

KROY®

Owner's Manual

Read this manual before using your K5100

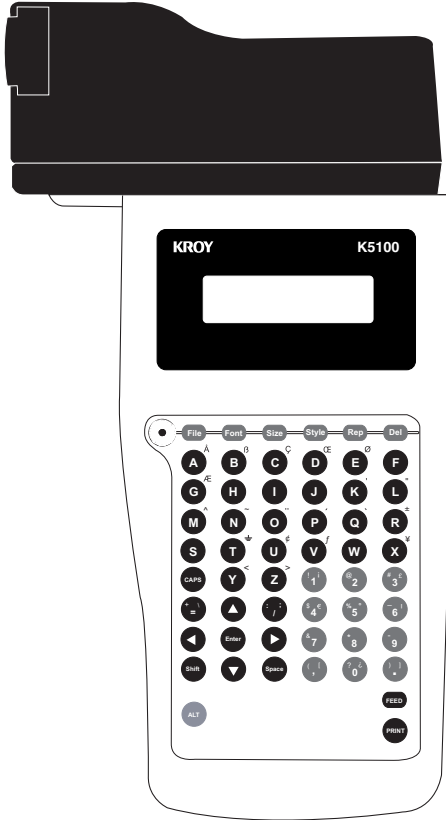

K5100 Handheld Label Printer

Toll Free 800.776.5769
Visit www.kroy.com

Order Number 2561100
Rev B 9/04

Introduction

Kroy Limited Warranty

Kroy LLC (“Kroy”) warrants its labeling system equipment against defects in material and workmanship for a period of six (6) months from the date of purchase. At no charge to the customer except for inbound freight to Kroy’s service center, Kroy will, at Kroy’s option, repair or replace any product determined to be defective. Kroy will pay return UPS ground charges. A purchase receipt or other evidence of purchase will be required before warranty service is rendered. This warranty does not cover cosmetic damage or any damage caused by accident, misuse, abuse, negligence or modification or attempted repair by anyone other than Kroy or a Kroy authorized repair agent. THERE ARE NO EXPRESS WARRANTIES EXCEPT AS SET FORTH IN THIS PARAGRAPH.

KROY SHALL NOT BE LIABLE FOR ANY INCIDENTAL OR CONSEQUENTIAL DAMAGES FOR BREACH OF ANY EXPRESS OR IMPLIED WARRANTY ON THIS PRODUCT. ALL EXPRESS AND IMPLIED WARRANTIES, INCLUDING WARRANTIES OF MERCHANTABILITY AND FITNESS FOR A PARTICULAR PURPOSE ARE LIMITED TO THE APPLICABLE WARRANTY PERIOD SET FORTH ABOVE.

Some states do not allow the exclusion or limitation of incidental or consequential damages, or limitations on how long an implied warranty lasts, so the above exclusions or limitations may not apply to you. This warranty gives you specific legal rights, and you may have other rights which vary from state to state.

If a problem develops with your Kroy labeling system during or after this warranty period, you may contact Kroy customer service at 800.729.5769.

FCC Notice

This equipment has been tested and found to comply with the limits for a Class A digital device, pursuant to part 15 of the FCC Rules. These limits are designed to provide reasonable protection against harmful interference when the equipment is operated in a commercial environment. This equipment generates, uses and can radiate radio frequency energy and, if not installed and used in accordance with the instruction manual, may cause harmful interference to radio communications. Operation of this equipment in a residential area is likely to cause harmful interference in which case the user will be required to correct the interference at his own expense.

Any changes or modifications not expressly approved by the manufacturer could void the user’s authority to operate the equipment.

CDC Notice

This digital apparatus does not exceed Class A limits for radio noise for digital devices as set out in the radio interference regulations of the Canadian Department of Communications.

Battery and AC Adapter Notice

This product is intended to be supplied by a Listed Power Unit AC adapter rated 12V DC, minimum 4.0A.



CAUTION: (for Lithium Battery) Risk of explosion if battery is replaced by an incorrect type. Dispose of used batteries according to the manufacturer’s instructions.

CAUTION: (for rechargeable Ni-Cd Batteries) Risk of explosion if batteries are replaced by an incorrect type. Replace only with C size Ni-Cd batteries rated 1.2V maximum 2500 mA.H. DO NOT USE ALKALINE BATTERIES IN THIS PRODUCT.

The K5100 Printer and Cartridges are protected by U.S. Patents including: 5,411,339 5,533,818

Table of Contents

Chapter 1: Getting Started

Contents of Box.....	3
Printer Description.....	4
Important Safety Precautions.....	5
Connecting AC Adapter.....	6
Installing Batteries (Optional).....	7
Charging Batteries.....	8
Installing the Supply Cartridge.....	9

Chapter 2: Printing Your First Label

Printing a Label.....	11
Turning Printer On.....	11
Cursor Movement.....	11
Default Printer Settings.....	11
Editing Text.....	12
Adding a Character Style.....	12
Printing on Shrink Tube.....	13
Printing a Self-Laminating Wire Wrap.....	14
Frequently Used Keys.....	15

Chapter 3: Operating Your Printer

Font Function.....	17
Size Function.....	18
Character Styles-	19-20
Bold, Italic, Underline	
Other Styles -	21-23
Mirror, Frame, Justify, Vertical, Rotate	
Label Setup.....	24-25
Length, Cutmark, Left Margin, Vertical Margin	
Shortcuts and Hot Keys.....	26
Multiple Copies & Sequencing.....	27-32
Printer Setup.....	33-34
Reset, Unit of Measure, Density, Auto Off, Advance Cut, Language,Printspeed	
Bar Codes.....	35-36
File Management.....	37-38
New , Open, Save, Delete	
Multiple Page Documents.....	39
Time/Date Stamp.....	40-41

Chapter 4: PC Operations

Introduction.....	43
KLDS Software and Driver Installation.....	44
KLDS Operation.....	45-46
Downloading Fonts.....	47-48
Using Your Printer with Other PC Applications.....	49-50

Appendices

Maintaining Your Printer.....	A-1
System Messages.....	B-1
Troubleshooting.....	C-1
Updating Printer Firmware.....	D-1 D-2
Using Accent Characters.....	E-1
Using the Character Map	F-1

Chapter 1
Getting Started

Contents of Box

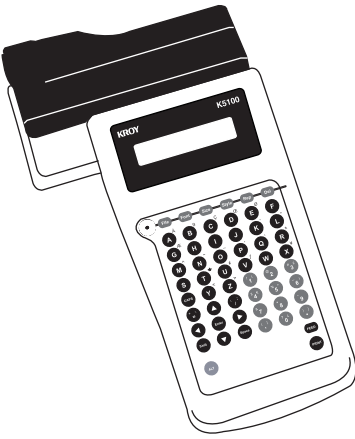

(1) K5100 Handheld Label Printer

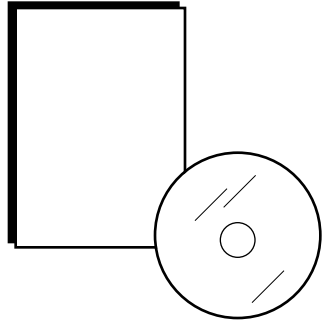

(1) Owner's Manual and (1) CD-ROM
with KLDS Software and Drivers

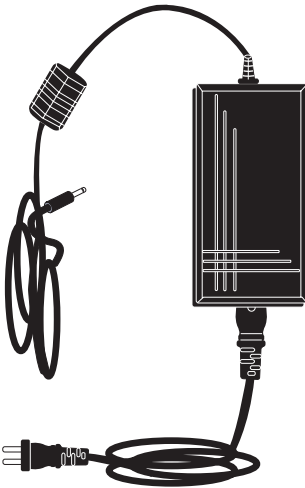

(1) AC Adapter with Power Cord

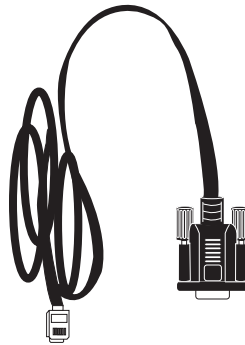

(1) Serial Cable

Printer Description

Figure 1: Top View of Printer

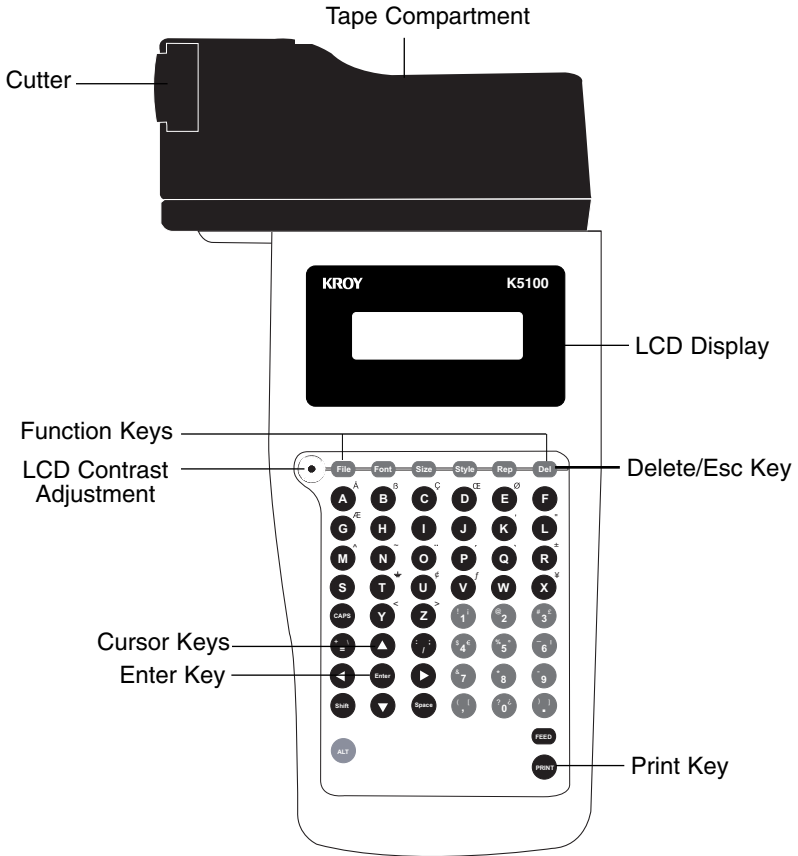
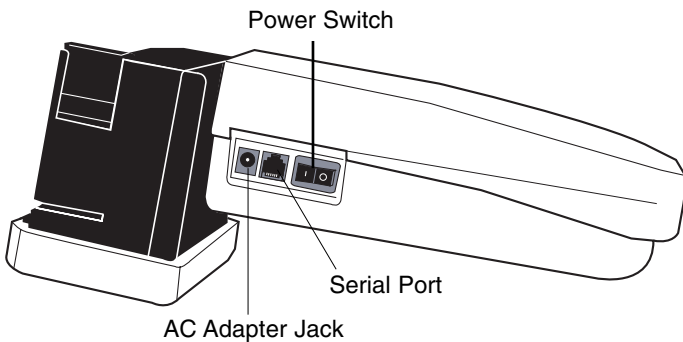

Figure 2: Left Side of Printer



Important Safety Precautions

When using your printer, always follow these important safety precautions:

1. Read all instructions carefully.
2. Do not immerse the printer in water or other liquids, you could receive an electrical shock.
3. Do not apply adhesive labels to your skin.
4. Do not put objects onto or into the printer.
5. Do not expose to high temperatures or high humidity. Never leave on the dashboard or in the trunk of your car.
6. Do not use in dusty places and avoid direct exposure to sunlight and rain.
7. Do not pull on the tape, you could damage the tape cartridge.
8. Do not attempt internal repairs to the printer. If service or repair is needed, contact a qualified Kroy service representative.
9. Do not touch the printhead ceramic or rollers with your fingers.

Connecting AC Adapter

The supplied AC adapter can be used to power the K5100. **Warning: Only use the AC adapter provided with this machine. Use of any other AC adapter may damage your K5100 and void the warranty.**

Connecting the AC Adapter

1. Insert the AC adapter plug into the AC adapter jack on the left side of the machine.
2. Plug the other end of the AC adapter into the nearest standard electrical outlet.

Figure 3: AC Adapter Connection

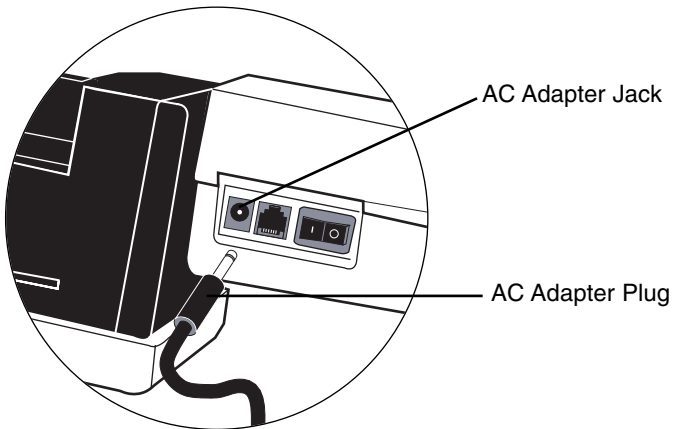

WARNING: K2500, K3000-PC and K240 AC adapters are NOT compatible with the K5100.

Installing Batteries (Optional)

Installing Batteries (Optional)

Your K5100 printer can optionally operate with six 2.5 Ampere-hour “C” size nickel cadmium batteries for primary power. **Do not replace with other type batteries.** These batteries can be purchased from Kroy or your Kroy dealer as accessory Part# 2449300 (6 pack Ni-Cd battery).

WARNING: Do not dispose of nickel-cadmium batteries in fire, mutilate, short-circuit, mix with other battery types. Batteries may explode, release toxic material, or get hot and cause personal injury.

Removing the Yellow Elastomer Jacket

1. Pull the jacket down from the top of the printer until clear of the top portion of the printer.
2. While holding the printer from the bottom, grab the top portion of the printer and lift it out of the jacket.
3. To replace the jacket reverse steps 1 and 2.

Note: The jacket must be removed to install batteries.

Installing the Nickel-Cadmium Batteries

1. Remove the battery cover by pushing down on the arrow and sliding it off the base in the direction of the arrow.

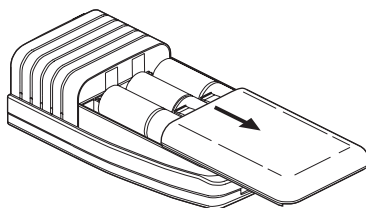

2. Insert the batteries according to diagram imprinted on the printer case under the batteries.

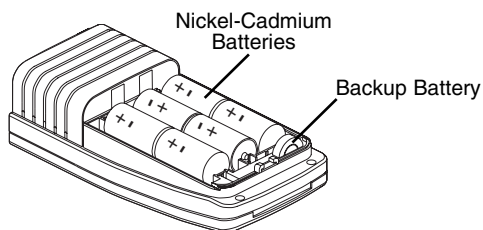

3. Replace battery cover.

Charging Batteries

Charging Main Batteries

The internal Ni-Cd battery charger operates when the AC adapter is connected to the K5100 printer. The normal complete charge cycle for fully discharged batteries is approximately 8 hours. The three LED's at the front of the printer indicate the internal battery charger status as shown below:

Charge Phase	Left LED (Green)	Middle LED (Amber)	Right LED (Green)
No Ni-Cd Battery Detected	Off	Off	Off
Battery Detected	Fast Flash	Off	Off
Soft Start Charge	Slow Flash	Off	Off
Charging	On	Slow Flash	Off
Topping Charge	On	Fast Flash	Off
Charge Complete	On	Off	On
Error	Fast Flash	Off	Fast Flash

When the two green LED's are ON, the charge cycle is complete and the AC adapter can be disconnected.

If the Error indication is present, the batteries should be replaced.

Installing the Supply Cartridge

Figure 4: Installing the Supply Cartridge

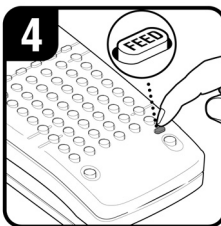
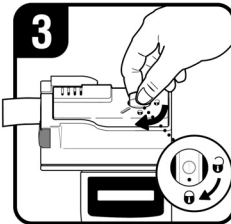
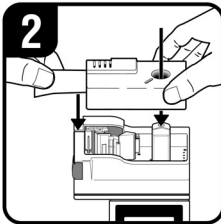
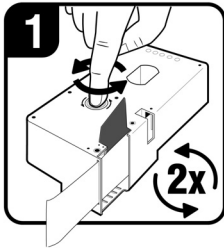
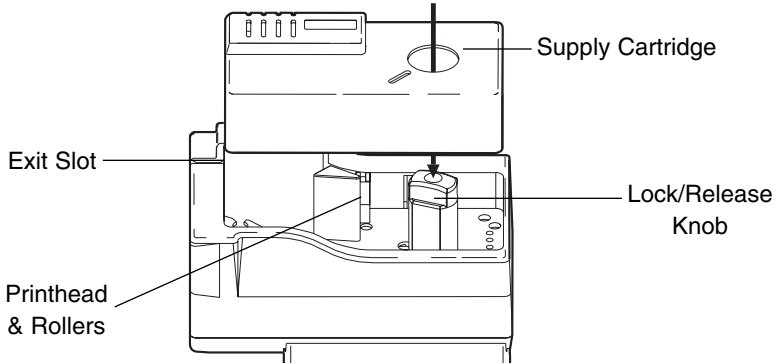

1. Wind the ribbon spool on the bottom of the supply cartridge counter-clock wise two full turns in the direction of the arrow with your finger.
2. Insert cartridge into the cartridge cavity with the lock/release knob turned counter-clockwise and the excess material threaded in the exit slot.
3. Turn the lock/release knob clockwise to lock the cartridge into place.
4. Press **FEED** and you are ready to create a label.

Chapter 2
***Printing Your First
Label***

Printing a Label

Turning the Printer On

Use the **Power** switch located on the left side of the printer to turn the printer on. The following displays will appear:



Cursor Movement

The underline seen above is the **cursor**. The cursor shows you the current typing position. **Cursor** keys move the cursor through text without changing it and through options without selecting any. The left and right cursor keys move left and right, one option or one character at a time; the up and down cursor keys move the cursor up and down through lines of text, one line at a time.

Adjusting LCD Contrast

The **LCD Contrast** allows you to lighten or darken the LCD of your printer. To darken the screen, turn the LCD contrast control clockwise. To lighten the screen, turn the LCD contrast control counter-clockwise.

Default Printer Settings

When the power is turned on for the first time, there are pre-programmed printer settings. One of these is the **Auto Size** feature. This feature auto sizes the text of your label to the current cartridge supply and size of media. You can find this function by pressing the **Size** key. You can always turn auto sizing off and type in a designated size, but for our example we will have auto sizing ON. The default font is "Block". No other font is installed on your K5100, however, other fonts of your choice can be downloaded into your K5100. The default justification is left. For more information on formatting and label setup see Chapter 3.

In the following examples, we have kept the default settings ON.

Type in the text "Cable 2E45"

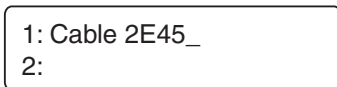

Now that your label is typed, you will press the **Print** Key and the auto sizing feature automatically sizes the text for the cartridge you are using.

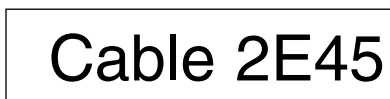

To make a two line label, press **Enter** at the end of line 1 and you will see the cursor go to line 2. Type in the text “Floor 2C” on line 2.

1: Cable 2E45_
2:

1: Cable 2E45
2: Floor 2C_

Now that you have two lines typed, press the **Print** key and the auto sizing feature automatically sizes the two lines for you.

Cable 2E45
Floor 2C

To add additional lines, perform the same function again.

Editing Text

You can correct or change characters by using the left and right cursor keys to move the cursor to the right of the character to be changed. Use the **Delete** key to delete the character and type in the correction. Below we changed the “E” on line 1 to “F” in our example.

Move the cursor to the right of “E” on line 1, press the **Delete** key and type in the letter “F”.

1: Cable 2E45
2: Floor 2C

1: Cable 2F45
2: Floor 2C

Adding a Character Style

You can change the style of text previously entered by using the left and right cursor keys to position the cursor to the beginning of your text. Press the **Style** key to select your character style of choice. To turn styles on and off use your **Enter** key.

In the following example, the cursor is moved to the beginning of the word “**Floor**” and **Bold** was then selected in the **Style** Menu. *Note: Only text to the right of the cursor will be changed.*

1: Cable 2F45
2: Floor 2C

Style Menu
■ Rotate *Bold _Italic

Now that your label has been edited and styled press the **Print** Key.

Cable 2F45
Floor 2C

Printing on Shrink Tube

Kroy offers flattened shrink tube cartridges for wire marking. Insert a shrink tube cartridge for this example.

You will start with a **New** file. To create a **New** file, press the **File** key and select **New** with the **Enter** key. Or use **Shift** and **File** as a shortcut.

For our example, we kept Auto Size ON.

Type in the following text “File Server”

1: File Server_
2:

Press the **Print** key. **Cut** the shrink tube label and insert the wire.



The tubing can be shrunk around the wire with a heat gun.

For further information on formatting the text of your shrink tube See Chapter 3.

Printing a Self-Laminating Wire Wrap

Kroy offers self-laminating wire wrap cartridges ideal for marking terminated wires and cables. Insert a self-laminating wire wrap cartridge for this example.

For our example, we kept Auto Size ON.

You will start with a **New** file. To create a **New** file, press the **File** key and select **New** with the **Enter** key. Or use **Shift** and **File** as a shortcut. When using a wire wrap cartridge, this will activate the automatic rotation feature. *Rotation is necessary because the printable area of a wire wrap is vertical and represents a small portion of the label.*

Type in the following text “300E”

1: 300E_
2:

Press the **Print** key then **Feed** and you have a wire wrap ready to apply.

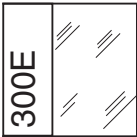

Apply the printed portion of the label to your wire and wrap the laminated tail around the wire.

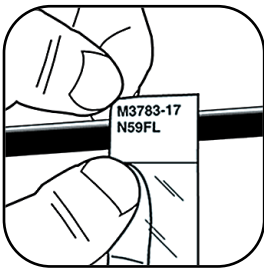

For further information on formatting the text of your wire wrap See Chapter 3.

Frequently Used Keys

The keyboard is used to enter label text and access menus. You will hear an audible click whenever a key is depressed. The frequently used keys on the keyboard are described below.

Function keys (File, Font, Size, Style, Repeat), will automatically prompt a list of selections to choose from. When using some function keys, the printer will display submenus or prompt you for information. These function keys also act as “toggles” which allow you to turn an option on or off.

The **Alt Key** accesses special character symbols shown in blue on particular keys. To enter a special character, (such as Å), hold down **ALT** and press the key of choice at the same time. To abort a print job, use the **Alt** and the **Print** keys together.

The **Cursor (Arrow) Keys** move the cursor through text without changing it and through options without selecting any. The left and right **Cursor** keys move left and right, one option or one character at a time; the up and down **Cursor** keys move up and down through lines of text, one line at a time. When used with **SHIFT**, the up and down **Cursor** keys act as **Page up** (previous label) and **Page Down** (next label) keys and the left and right **Cursor** keys move the cursor one word at a time.

The **Caps Key** locks capital letters on. Pressing the **Caps** key again turns off the function. The **Caps** key does not effect the number keys.

The **Delete Key** allows you to cancel functions or escape from menus. **Delete** erases characters to the left of the cursor. To **Delete** an entire line, hold down **Alt** and the **Delete** key together.

The **Enter Key** in typing mode, moves the text or the cursor to the next line. In function mode, the **Enter** key selects specific menu options, file names and default printer settings.

The **Feed Key** advances the tape from the printer.

The **Print Key** prints the current label and advances the tape far enough to clear the cut mechanism.

The **Shift Key** capitalizes individual letters and accesses the black characters on the number keys (such as !). Using the **Shift** and **File** key creates it clears text allowing you to create a new label.

Chapter 3
***Operating Your
Printer***

Font Function

Using the Font Menu

When you select the **Font** key the printer displays the default “Block” font seen below. *This is the only font included with the K5100.*



K5100 has the *option* of downloading fonts from your PC. When you download a font, it will be added to your Font menu.



Press **Enter** to accept the current Block font or use the left and right cursor keys to move the cursor to the left of the font you want and press **Enter** to select it.

See **Downloading Fonts** on **Pages 43-44** for further information.

Size Function

Using the Size Menu

Select **Size** to specify the print size for your text. The printer displays the default **Auto Size** function and waits for your entry. Press **Delete** to accept auto sizing or type a different size and press **Enter**. Valid sizes of 4-72 pt can be entered.

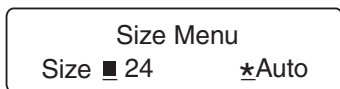

When printing, the K5100 will show what point size is being printed in the auto size mode. See below.

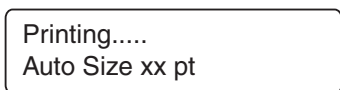

If you select **Auto Size**, the K5100 will automatically adjust the print size based on the number of lines of your label and the width of the label media. If you turn auto size off, the size of the print you select must take into account the number of lines of your label and the width of the media.



If auto size calculates a point size smaller than 4 point, an error message will be displayed.



If the text you have typed is too large, an error message will be displayed.

See the table below which can be used as a guide. The table assumes using characters of all the same size (capital letters). When using characters of varying size (such as lower case letters or accent characters) or using character styles (such as bold, italic etc.) the maximum point sizes will vary slightly.

Tape Size	1 Line	2 Line	3 Line	4 Line	5 Line	6 Line
0.375"	28 pt	11 pt	8 pt	N/A	N/A	N/A
0.50"	38 pt	19 pt	12 pt	8 pt	N/A	N/A
0.80"	60 pt	30 pt	20 pt	15 pt	11 pt	N/A
1"	72 pt	36 pt	24 pt	18 pt	14 pt	12 pt

Character Styles

This section explains how to use the **Style** key to assign text formatting attributes to your label text. There are three types of text attributes: character, line and page. These attributes, as well as their defaults and options, are shown in the following table.

Attribute	Defaults	Options
Font	Block	Download True Type Fonts from PC
Size	Auto Size On	.50" 4-30 point size .80" 4-55 point size 1" 4-72 point size
Justification †	Left	Left, Center, Right
*Bold	Off	On, Off
*Italic	Off	On, Off
*Mirror ‡	Off	On, Off
*Vertical ‡	Off	On, Off
*Frame	Off Off	Page: On, Off Line: On, Off
*Underline	Off	On, Off
Rotate ‡	Off	On, Off

* Attributes marked with an asterisk are toggles. † are line attributes. They affect the entire line of text that the cursor is positioned on. ‡ are page attributes. They affect the entire page (label). All other attributes (except **Frame**) are character attributes only and affect the text from the point that the cursor is positioned.

The following style settings are available on the K5100: Rotate, Bold, Italic, Underline, Justify, Mirror, Frame and Vertical.

To Select Multiple Styles, with less keystrokes, use the **Space** key and the cursor keys to turn styles on and off. *For more Shortcuts, See page 24.*

*Note: When the **Style** menu is selected, all selections are not visible on the LCD display - you will have to use your left and right cursor keys to scroll through all the choices.*

The most common character styles used are **Bold**, *Italic* and Underline.

To emphasize the text of your label using **Bold**, move the cursor to the position where you want to apply the **Bold** attribute and press the **Style** key. Use the left and right cursor keys to move the cursor to the left of **Bold** and press **Enter**. When turned on, an asterisk will appear. To turn **Bold** off, press **Enter** again or to exit press **Delete**.

1: ATENTION
2:

Style Menu
■ Rotate *Bold _Italic

Bold Example:

ATTENTION

To italicize the text of your label using **Italic**, move the cursor to the position where you want to apply the **Italic** attribute and press the **Style** key. Use the left and right cursor keys to move the cursor to the left of **Italic** and press **Enter**. When turned on, an asterisk will appear. To turn **Italic** off, press **Enter** again or to exit press **Delete**.

1: ATENTION
2:

Style Menu
■ Rotate _Bold *Italic

Italic Example:

ATTENTION

To underline the text of your label using **Underline**, move the cursor to the position where you want to apply the **Underline** attribute and press the **Style** key. Use the left and right cursor keys to move the cursor to the left of **Underline** and press **Enter**. When turned on, an asterisk will appear. To turn **Underline** off, press **Enter** again or to exit press **Delete**.

1: ATENTION
2:

Style Menu
* Underline _Justify

Underline Example:

ATTENTION

Other Styles

Other character styles include Mirror, Frame, Justify, Vertical and Rotate.

To reverse the text of your label using **Mirror** press the **Style** key. Use the left and right cursor keys to move the cursor to the left of **Mirror** and press **Enter**. When turned on, an asterisk will appear. To turn **Mirror** off press **Enter** again or to exit press **Delete**. When using mirror image, use clear tape for best results.

1: ATENTION
2:

Style Menu
* Mirror _Frame

Mirror Example:

NOITNƎTTA

To draw a box around the text of your label using **Frame** press the **Style** key. Use the left and right cursor keys to move the cursor to the left of **Frame** and press **Enter**. When turned on, an asterisk will appear. The printer displays the frame menu and waits for you to select the type of frame you want. To turn **Frame** off, press **Enter** again or to exit press **Delete**.

Style Menu
_ Mirror *Frame

Once **Frame** is selected, the **Frame Menu** will appear. To frame all the text on the label, select **Page** by pressing the **Enter** key. When turned on, an asterisk will appear

1: ATENTION
2: EMPLOYEES

Frame Menu
* Page _Line

Page Frame Example:

ATTENTION
EMPLOYEES

To frame just a line of text, move the cursor to the line of your text and select **Line** by pressing the **Enter** key. When turned on, an asterisk will appear

1: ATTENTION_
2: EMPLOYEEES

Frame Menu
_ Page *Line

Line Frame Example:

ATTENTION
EMPLOYEEES

To justify the text of your label using **Justify** press the **Style** key. Use the left and right cursor keys to move the cursor to the left of **Justify** and press **Enter**. The printer displays the justify menu and waits for you to select the justification of your choice. To exit the **Justify** menu press **Enter** or the **Delete** key. *Note: The default justification is left.*

1: ATTENTION
2: PLEASE

Justify Menu
* Left _Center _Right

Left Justification

ATTENTION
PLEASE

Center Justification

ATTENTION
PLEASE

Right Justification

ATTENTION
PLEASE

To print the text of your label vertically instead of horizontally using **Vertical**, press the **Style** key. Use the left and right cursor keys to move the cursor to the left of **Vertical** and press **Enter**. When turned on, an asterisk will appear. To turn **Vertical** off press **Enter** again or to exit press **Delete**.

1: ATENTION
2:

Style Menu
* Vertical _Rotate

Vertical Example:



To rotate the text of your label using **Rotate**, press the **Style** key. Use the left and right cursor keys to move the cursor to the left of **Rotate** and press **Enter**. When turned on, an asterisk will appear. To turn **Rotate** off, press **Enter** again or to exit press **Delete**.

Rotation and Vertical are not the same. Note: Mirror is ignored when rotation is selected.

1: 300E_
2:

Style Menu
* Rotate _Bold

Rotate Example:

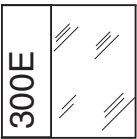

Auto Rotation

When a self-laminating wire wrap cartridge is installed, the K5100 will automatically rotate and auto size the text using the instructions below.

You will start with a **New** file. To create a **New** file, press the **File** key and select **New** with the **Enter** key. Or use **Shift** and **File** as a shortcut. This will activate the auto rotation feature.

Label Setup

To select the **Label Setup** press the **Shift** and the **Style** key together. The prompt below will appear. The menu options are length, cutmark, left margin and vertical margin.

Label Setup
■ Length _Cutmark

In the default setting, the **Length** of a printed label automatically adjusts to fit the length of text. If you want to specify the length of a label, the **Length** function allows you to set the length between 0.3" and 20". To turn **Auto** off, type in your specific length and press **Enter**. To exit the length menu without making any changes press **Delete**.

Length Menu
Len■ 0.3 *Auto

The **Cutmark** function creates cutmarks along a print job. Use the left and right cursor keys to move the cursor to the left of **Cutmark** and press **Enter**. When turned on, an asterisk will appear. To turn **Cutmark** off press **Enter** again or to exit the menu without making any changes press **Delete**.

Label Setup
■ Length *Cutmark

Room 5 Room 6
Floor 2C Floor 2C

The **Left margin** function allows you to increase the size of your left margin by moving text from the left to the right of your label. The amount is measured in pixels. Use the left and right cursor keys to move the cursor to the left of **Leftmargin** and press **Enter**. A prompt will appear. Use the right and left cursor keys to select an increment up to 30 pixels. Press **Enter** to select the increment of choice. See the example below.

This function is used with die cut labels and self-laminating wire wraps only.



The text seen here has printed right to the edge.

Left Margin
Margin: ■ +5

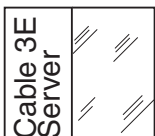

The text is now adjusted.

The **Vertical margin** function allows you to move text from the top to the bottom by pixel on your label. Use the left and right cursor keys to move the cursor to the left of **Vertmargin** and press **Enter**. A prompt will appear below. Use the right and left cursor key to select an increment up to 30 pixels. Press **Enter** to select the increment of choice. See the example below.



The text seen here has printed to the bottom of the label.



The text is now adjusted upward on the label.

Shortcuts and Hot Keys

A **Shortcut** will provide a direct route to some submenus and options. See the listing below. *To use a shortcut, first press and hold the **Shift or Alt** key and then press the second key.*

Shift + File	Creates a New File / Erases All Text
Shift + Font	Bar Code Menu
Shift + Size	Toggle Auto Size On/Off
Shift + Style	Label Setup
Alt + Style	All Styles Reset
Shift + Repeat	Time/Date Menu
Shift + Delete	Printer Setup
Alt + Print	Stops Print Job
Alt + Delete	Erase Current Line

The **Space** key can be used to select multiple items on a menu. For example, in the **Style Menu**, if you want **Bold** and **Italic** on at the same time simply use your cursor key and the **Space** key to select these options and then exit the menu using the **Delete** key.

Hot keys are represented by a capitalized letter in most function key menus (i.e. New Open Save). For example, the **File Menu** is selected. By pressing the letter "**N**", a new file will be selected without using the cursor keys and the enter key. **Hot** keys turn menu options on and off. And they also act as a shortcut to submenus. *Note: The function key must be selected first before using the hot key. Hot keys work only in function mode.*

Below is a listing of some of the function menu's hot keys.

File Menu Hot Keys

"**N**" New File

"**O**" Open File Menu

"**S**" Save File Menu

"**J**" Justify Menu

"**L**" Left Justify On/Off

"**C**" Center Justify On/Off

"**R**" Right Justify On/Off

"**M**" Mirror On/Off

"**F**" Frame On/Off

"**V**" Vertical On/Off

Size Menu Hot Keys

"**A**" Auto Size On/Off

Style Menu Hot Keys

"**R**" Rotate On/Off

"**B**" Bold On/Off

"**I**" Italic On/Off

"**U**" Underline On/Off

Repeat Menu Hot Keys

"**S**" Sequence Menu

"**I**" Insert

"**A**" Alpha On/Off - Sequence Start/End

"**N**" Numeric On/Off - Sequence Start/End

Multiple Copies and Sequencing

This section explains how to use the **Repeat** key to print multiple copies of a file or sequence text either numerically or alphabetically.

Press the **Repeat** key to make copies or sequence labels. The prompt below will appear.

Repeat Menu
■ Sequence _Copies

Select **Copies** to specify the number of copies you want to print (1-999). Use the left and right cursor keys to move the cursor to the left of **Copies** and press **Enter**. The printer displays the current setting for this option (see the following example) and waits for your entry. Press **Delete** to accept the number of copies shown, or type in your specific number and press **Enter**. Press **Print**.

Copies Menu
Copies: ■ 2

Select **Sequence** to automatically generate and print labels containing a sequence of one letter or one to three numbers (101 102 103, ABC....etc.) without having to type the text of each label yourself. You simply tell the printer what characters to print on the first and last labels and how much to increment between labels (see following table).

Printing Sequential Labels

Start	Stop	Increment	Individual Labels Printed
1	10	1	1 2 3 4 5 6 7 8 9 10
01	10	1	01 02 03 04 05 06 07 08 09 10
001	10	1	001 002 003 004 005 006 007 008 009 010
2	12	2	2 4 6 8 10 12
A	J	1	A B C D E F G H I J
a	z	4	a e i m q u y

The sequence character takes on the current character attributes previously defined. Optionally, you can redefine the sequence character's attributes like any other character. *Note: You can only define one sequence type (numeric or alpha) per document/file, but you can place the sequence character in your document/file once on each line.*

Select **Sequence** from the **Repeat** menu. The **Sequence** menu will appear.

Sequence Menu
■ Insert *Alpha _Num

Use the left and right cursor keys to move to the left of the option you want and press **Enter** to select it.

Example 1

If you choose **Alphabetic**, the printer prompts you to enter the first letter to start the sequence. Type the first letter of your choice and press **Enter**.

For our example, we have selected the letter "A".

Sequence Start
Start: ■ A

The printer then prompts you to enter the last letter to end the sequence. Type the last letter of your choice and press **Enter**.

Sequence End
End: ■ C

The next prompt you will enter the increment amount. Press **Enter**.

Sequence Inc
Inc: ■ 1

You will then select **Insert** from the **Sequence** menu by pressing **Enter**. This will place the sequence where you would like it to begin. A black box will be seen where the sequence will start. See example below.

1: Wire_■
2:

Press the **Print** key.

Wire A Wire B Wire C

For multiple labels, Press the **Repeat** key and the **Repeat** menu will appear. Toggle your cursor to the left of **Copies** and press **Enter** to select.

Repeat Menu
_Sequence █ Copies

The number of copies can either be typed in or you can use your up and down cursor keys. In our example, we have selected 2 copies. Press **Enter**.

Copies Menu
Copies: █ 2

Press the **Print** key.

Wire A Wire A Wire B Wire B

Example 2

If you choose **Numeric**, the printer prompts you to enter the first number to start the sequence. Type the first number of your choice and press **Enter**.

For our example we have selected two digits.

Sequence Start
Start: █06

Enter the last number to end the sequence. Type the last number of your choice and press **Enter**.

Sequence End
End: █12

The next prompt you will enter the increment amount. Press **Enter**.

Sequence Inc
Inc: █ 2

You will then select **Insert** from the **Sequence** menu by pressing **Enter**.

A black box will be seen where the sequence will start.

1: A█
2:

Press the **Print** key.

A06 A08 A10 A12

Example 3

Here is another example of a numeric sequence using an increment of 2 and triple digits.

Enter the first number to start the sequence. We chose “006” for this example. Press **Enter**.

Sequence Start
Start: █006

Enter the last number to end the sequence. We chose “12” for this example. Press **Enter**.

Sequence End
End: █12

The next prompt you will enter the increment amount. Press **Enter**.

Sequence Inc
Inc: █ 2

You will then select **Insert** from the **Sequence** menu by pressing **Enter**. A black box will be seen where the sequence will start.

1: █
2:

Press the **Print** key.

006 008 010 012

Example 4

Here is an example of using multiple pages and numeric sequencing. For our example, we have typed “Line In” on the label (Page 1).

1: Line In_
2:

Press the **Repeat** key and select **Sequence** by pressing **Enter**. Toggle the cursor to the left of **Numeric** and press **Enter** again.

Sequence Menu
■ Insert _Alpha ✱Num

Enter the first number to start the sequence. We chose “1” for this example. Press **Enter**.

Sequence Start
Start: ■ 1

Enter the last number to end the sequence. We chose “2” for this example. Press **Enter**.

Sequence End
End: ■ 2

The next prompt you will enter the increment amount. Press **Enter**.

Sequence Inc
Inc: ■ 1

You will then select **Insert** from the **Sequence** menu by pressing **Enter**. A black box will be seen where the sequence will start.

1: Line In ■
2:

To start a new page, use the **Shift** and the **Down Cursor** key to move to the next page. A prompt will appear with the page number.

Page 2

We have typed “Line Out” on the label (Page 2).

1: Line Out_
2:

Follow the same steps for the sequence setup on Page 1 and Insert the sequence. A black box will be seen where the sequence will start.

1: Line Out ■
2:

Press the **Print** key.

Line In 1 Line Out 1 Line In 2 Line Out 2

Printer Setup

To select the **Printer Setup** press the **Shift** and the **Print** key together. The prompt below will appear. The menu options are reset, unit of measure, density, auto off, advance cut, language, printspeed and lcd contrast.

Printer Setup
■ Reset _Unit _Density

Select **Reset** to restore all factory settings and defaults. To select **Reset** press **Enter** or to exit press **Delete**.

1:■
2:

The **Unit of Measure** function allows you to choose the unit of measure you want to use for setting label width and margin. The options are tenths of an inch (default) and millimeters. Select **Unit** from the printer setup menu by using the cursor keys and pressing **Enter**. The unit menu will appear. Use the arrow keys to move to the left of the option you want and press **Enter**. To accept the current setting press **Delete**.

Unit Menu
■ *Inch _MM

Select **Density** to specify the density (0-7) for printing the current label. **Density** will make the label darker or lighter per unit measure. The printer displays the current density setting and waits for your entry. Press **Delete** to accept the value shown, or use the left cursor key to add density and press **Enter**.

Density Menu
D: ##### ■

If the characters are smeared on a label or are not completely filled in, you can attempt to fix the problem by adjusting the print density. If the characters are smeared, specify a lower number in the field; if the characters are not completely filled in, specify a higher number. You may need to adjust the density after installing a new tape.

Select **Auto Off** to activate auto shut off. The factory default is to shut off the printer after 5 minutes of non-use. When the printer is turned off, all current label text and text attributes settings are saved. All files in memory are still saved. Press **Delete** if you decide you do not wish to change the current setting. Or press **Enter** to activate auto shut off. When turned on, an asterisk will appear. By default, this function is on.

The **Advance to Cut** function advances the label material to the cut position. The default setting is advance to cut enabled. If you do not need this function you may disable the advance to cut function by using the cursor keys to move to the left of **Advance** in the printer setup menu and press **Enter**.

The **Language** function allows you to choose from 4 different languages. The default language is English. Other options are spanish, french and german. Select **Language** from the printer setup menu by using the cursor keys and press **Enter**. The language menu will appear. Use the cursor keys to move to the left of the language you want and press **Enter**. To accept the current setting press **Delete**.

Languages Menu
* English _eSpanoL _Francai _Deutsch

Printspeed is the rate at which the label advances from the printer when printed. The default printspeed is unlimited. To specify a printspeed, select **PrtSpeed** from the printer setup menu by using your cursor keys and press **Enter**. The printspeed menu will appear and by using your cursor keys you can select from the options below by pressing **Enter**. To accept the current setting press **Delete**.

PrtSpeed Menu
* Unlimit _0.5 _0.8 _1.0

Bar Codes

To print a **Bar Code**, press the **Shift** and the **Font** key together. Use the **Bar Code Menu** to specify the type of bar code you want to print.

BARCODE Menu

■ None _codaBar _Code39 _Ean8 _eAn13 _I2of5

BARCODE Menu

_Upca _uPce _coDe128 _Msiplessey _pdF417

K5100 has ten bar codes built-in. The following table summarizes information on these bar codes. The

Bar Code Type	Valid Characters	Checksum Options Available	Fixed Length	Special Restrictions & Other Information
Codabar	0 -9 A - D .- \$ / + %	None, mod 10, mod 16	< 32 characters	First and last characters must always be either A, B, C, or D. Letters not allowed in body of bar code
Code 39	0 -9 A - Z .- \$ / + % space	None, mod 43	< 32 characters	Lowercase letters not allowed
EAN-8	0 -9	EAN-8	7, 9 or 12 digits	Length varies because of optional 2 or 5 digit supplemental
EAN-13	0 -9	EAN-13	12, 14 or 17 digits	Length varies because of optional 2 or 5 digit supplemental
Interleaved 2 of 5	0 -9	None, mod 10	Even number of digits	Printer adds leading zero, if needed, to make the length even
UPC-A	0 -9	None	11, 13 or 16 digits	Length varies because of optional 2 or 5 digit supplemental
UPC-E	0 -9	None	6, 8 or 11 digits	Length varies because of optional 2 or 5 digit supplemental
Code 128	128 ASCII Character Set	None	< 32 characters	See Appendix D
MSI Plessey	0 -9	None, mod 10, mod 11	< 16 characters	Mode 11 checksum cannot equal 10
PDF 417	All ASCII characters	0 to 400 levels of security	< 700 characters	None

After the bar code selection has been made, press the **Shift** and **Font** keys together to go back to the **Bar Code** menu. The menu will change allowing you to customize the bar code selected using code, text and resolution.

BARCODE Menu

■ Code _Text _Resolution

Select **Code** to change the type of bar code you want to print. The printer displays the types of bar codes available. Use the left and right cursor keys to move to the left of the option you want and press **Enter**. If an asterisk displays to the left of the option, selecting it turns code off.

Depending on the bar code you have selected, some bar codes allow you to choose whether to include a checksum and change the resolution at which the bar code is printed as well as whether to print text or the checksum.

Select **Text** to print text as part of the bar code. Use the left and right cursor keys to move to the left of the option you want and press **Enter**. If an asterisk displays to the left of the option, selecting it turns text printing off. Text is printed in the following manner:

- Code 39, Code 128, Interleaved 2 of 5 and MSI Plessey: text is printed immediately beneath the symbol.
- EAN8, EAN13 and UPC: text for the number system is printed at the left of the symbol; text for the product and manufacturer code is printed beneath the symbol; text for the supplemental is drawn above the symbol.
- PDF 417 has no text option.

Resolution specifies whether you want to print the bar code at normal or high resolution. Use the left and right cursor keys to select the option you want and press **Enter**.

Resolution Menu
* Medium _High

Checksum specifies the type of error checking you want to use. The type of bar code selected at **Code** determines the prompt that displays next. For example, if you selected 12 of 5, the following prompt displays:

BARCODE CheckSum
* Mod10 _Mod16

Some bar code symbologies allow you to print the checksum value as part of the bar code

File Management

To select the **File Menu** press the **File** key. Use the **File Menu** to create new files, open files, save files and delete files.

File Menu

■ New_Open_Save_Delete

Select **New** to create a new document. The printer clears any text displayed on the screen, returns all attributes to factory defaults and displays a blank edit screen so you can enter new text. To create a **New** file, press the **File** key and select **New** with the **Enter** key. Or use **Shift** and **File** as a shortcut.

1:■

2:

Select **Open** to access an existing document you want to edit or print. The printer displays a list of file(s) you have saved (see the following example) and waits for you to select the file you want to work with. Press the **File** key and use the cursors to scroll to the left of **Open** and press **Enter**. The **Open File Menu** is now displayed. Use the left and right cursor keys to scroll to the left of the file want to open and press **Enter** to select it. See example below.

Open File Menu

■ Address _Job 4048 _ww

Select **Save** to save the current document. You must save the label you are working on before you select either **New** or **Open**. If you do not save first, it will be lost. Press the **File** key and use the cursors to scroll to the left of **Save** and press **Enter**. The **Save File Menu** is now displayed prompts you to enter a file name..

Save File Menu

■

File names can be any combination of letters and numbers, 8 character maximum, with no punctuation or file name extensions.

If you enter a file name for an already existing file, you will see the following message:

Overwrite?
OK? (Y,N)

Press **Y** to overwrite or **N** to enter a different file name. If you decide not to save the file, simply press **Delete**.

Select **Delete** to delete files that you no longer need. Press the **File** key and use the cursors to scroll to the left of **Delete** and press **Enter**. The **Delete File** menu displays a list of files you have saved (see the following example) and waits for you to select the file you want to delete. Use the left and right cursor keys to move the cursor to the left of the file you want to delete and press **Enter** to select it. If you decide not to delete a file, simply press **Delete**.

Delete File

■ Address _Job 4048 _ww

Multiple Page Documents

You can enter multiple labels in a file by using **Page Up** and **Page Down** to access additional pages (labels). In this case, you can think of a file as a single document containing one or more pages (labels). Each label can be up to six lines.

```
1:█  
2:
```

To start a new page while you are in a file, use the **Shift** and the **Down Cursor** key to move to the next page. A prompt will appear with the page number.

```
Page 2
```

To move back to the preceding page, use **Shift** and the **Up Cursor** key. When you press the **Print** key, all pages in the file will be printed.

Time/Date Stamp

To select the **Time/Date Menu** press the **Shift** and **Repeat** keys together. Use the **Time/Date Menu** to print labels with

Time/Date Menu
■ Time _datE _stamP _setclocK _24Hourmode

To use the Time/Date functions you must first set the real time clock with the local time and date. This will lock the time and date into memory. This will have to be done once with the exception of summer and winter time changes.

Select **Set Clock** to enter the current time and date in the printer. Use the cursor keys to scroll to the left of **Set Clock** and press **Enter**. The prompt below will appear. Use the **Up and Down** cursor keys to scroll through the menu.

The information will be entered in the order shown here:

Year_
Month_
Day_
Hour_
Minute_
Second_

Set Clock Parameters

Prompt	Parameters
Year	Last two digits of the year
Month	Number from 1 to 12
Day	Number from 1 to 31
Hour*	Number from 0 to 23
Minute	Number from 0 to 59
Second	Number from 0 to 59

* Hour is entered in 24 hour mode (i.e. 1PM would be entered as 13)

Select **Time** to add the current time to your label. Use the cursor keys to scroll to the left of **Time** and press **Enter**. The time will be added to the label where the cursor is positioned. The time can be formatted or deleted just as you had physically typed it in.

1:03:48:33PM■
2:

Select **Date** to add the current date to your label. Use the cursor keys to scroll to the left of **Date** and press **Enter**. The **Date Menu** will appear offering 6 formats (mm/dd/yy, dd/mm/yy, mm/dd/yyyy, dd/mm/yyyy, dd.mm.yy, dd.mm.yyyy). Use the cursor keys to scroll to the left of the format you want and press **Enter**.

Date Menu
■ mm/dd/yy _dd/mm/yy _

The current date will be added to the label where the cursor is positioned. The date can be formatted or deleted just as you had physically typed it in.

1: 02/01/04 ■
2:

*Note: Do not confuse the Time and Date options with the Stamp option. Time and Date enters the current time/date into your label at the insertion point, once entered they are now considered text by the printer (as if you typed them by hand). **The Stamp function will always use the current time clock at the time of print job.***

Select **Stamp** to have the current date and time (at the time of print) printed vertically on the very edge of the label. Every time you press print a stamp with the current date and time will be printed in ddhhmmMMMyy format. Use the cursor keys to scroll to the left of **Stamp** and press **Enter**. This will turn **Stamp** on and an asterisk will be displayed. To turn it off, press **Enter** again.

1612-01Feb04

File Backup -
Marketing

Note: Using the stamp on tape supply sizes 0.50" and smaller is not recommended.

Select **24 Hour Mode** causes time entered in the text of a label via the Time option to be in 24 hour mode (i.e., 1 PM as 13). Use the cursor keys to scroll to the left of **24 Hour Mode** and press **Enter**. This will turn **24 Hour Mode** on and an asterisk will be displayed. To turn it off, press **Enter** again.

Chapter 4
PC Operations

Introduction

The K5100 will operate either standalone or as a PC printer. This new printer will operate with Microsoft Windows 98, ME, 2000 or XP. Any standard windows application such as Word, Excel or other programs can print to the K5100 via a standard Windows printer driver.

Kroy also includes the Kroy Label Designer Software (KLDS) application with your printer that contains easy to use, preformatted templates for your printer.

The communications between your printer and your PC are controlled by a windows printer device driver.

The printer device drivers are located on the included software CD-ROM or current drivers are available at www.kroy.com

KLDS Software and Driver Installation

Installing the KLDS Software

Close all programs prior to installation. Insert the Kroy Label Designer into the CD-ROM drive. On most systems the installation program will automatically start. See the steps below to help you along with your setup.

1. The InstallShield Wizard will appear and prepare to install.
2. Kroy Label Designer Setup will appear. Click **Next** to continue installation.
3. The License Agreement will appear: Click **Yes**.
4. Choose the Destination: the default will be C:\Program\Kroy Click **Next**.
5. You will then choose the Setup Type. The default is **Typical** and is recommended for most users. Click **Next**.
6. Click **Finish** to complete.

Installing the Printer Drivers

The drivers for the KLDS will automatically setup. You will see the following prompts once the software portion is complete.

1. Do you wish to install Kroy Printers. Click **Yes**.
2. The Kroy Printer Driver Setup will then appear. Click **Next** to continue.
3. You can now select to add your Kroy Label Printer under Setup Type. Click **Next** to continue.
4. Select the mode of printer installation. Choose **Automatic** and connect the printer to your PC using the serial cable. Turn the printer on.
5. Setup will then scan the COM ports on your system for the new printer, Click **Next**.
6. Name your Kroy Printer and select it as your default label printer by selecting **Yes**. Click **Next**.
7. Recommended Port Setting will appear and click **OK**.
8. Click **Finish** to complete.

KLDS Operation

Creating a Label

Double click the KLDS Icon or go to your Start Menu\Programs\Kroy Label Designer and select it. The main screen will appear.

1. Go to the **Label** Menu and select **Label Setup**. Click on the K5100 printer. Click OK to verify.

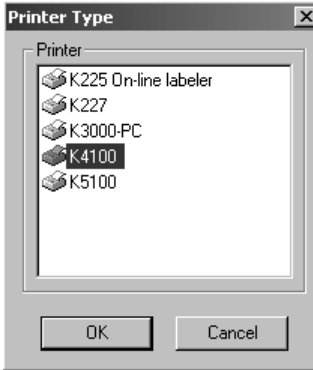

2. Select the appropriate Supply Type, Size and Label Orientation that you are using in your K5100.

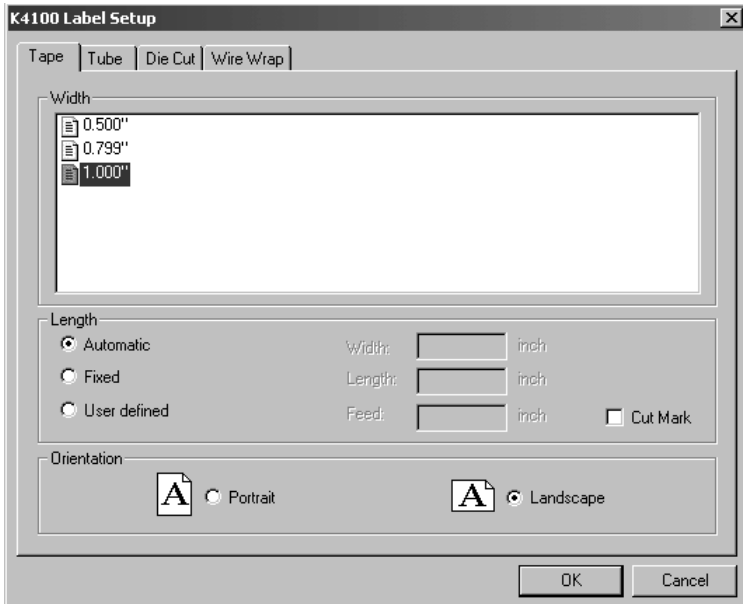

3. A label template will appear on the Main Menu Screen. Select the **Text Tool “A”** from the Main Tool Bar, click your left mouse button on the label template and input text at the blinking cursor.

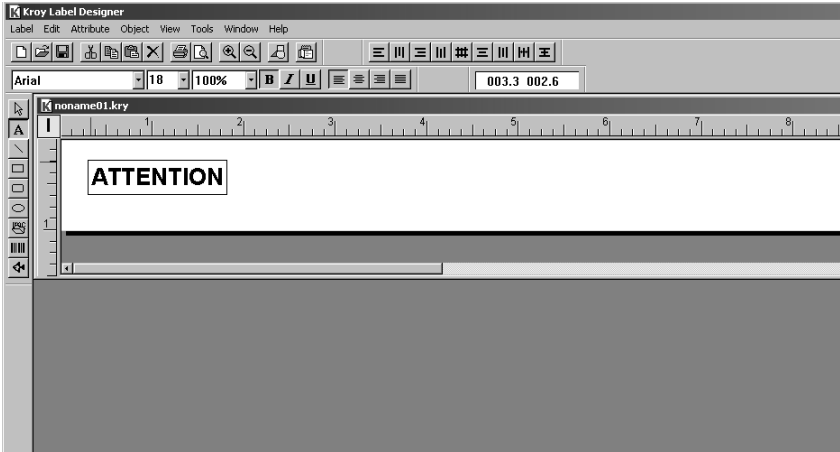

4. After creating your label, click on the **Print Icon** from the top tool bar, or go to the Label Menu and select **Print**. Select the number of copies and click **OK** to print your label.



5. The K5100 will then print your label.

For further assistance, go to the **Help Menu** of your KLDS Software.

Downloading Fonts

Downloading a Font

The K5100 has the option of downloading fonts from the PC into your Font Menu. Follow the steps below.

1. **Connect** the serial cable to the com port of choice and to your printer.
2. Go to the **Start Menu** of your PC and go to **Settings** and select **Printers**.
3. Right click on the K5100 driver and go to **Properties**.

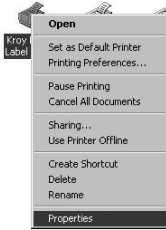

4. Click on **Control** and go to **Advance Options...**

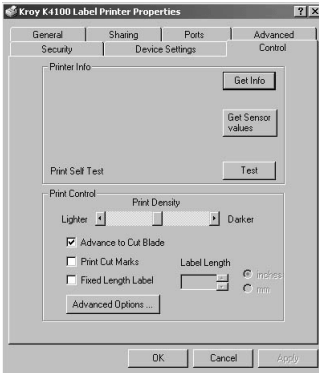

5. Select **Download Fonts** from the Menu and click **Update**.

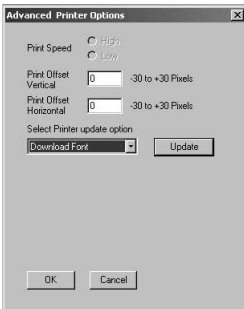

6. Go to the **Font** folder on the C drive of your PC and click OK.

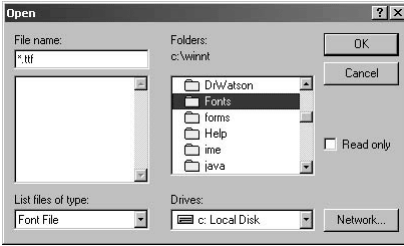

7. Select the Font or Font Family of your choice and click OK.

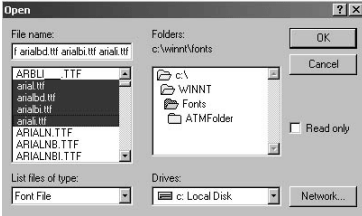

8. The LCD Display of the printer will show the progress of the download using the pound sign(#) across the bottom. The printer will show a receiving and an updating display.

Receiving...
#####

Updating...
#####

9. The download is now complete and you can find the font in your **Font Menu**. Press the **Delete** key to accept the current Block font or use the left and right cursor keys to move the cursor to the left of the font you want and press **Enter** to select it.

Font Menu
■ Block_times_arial

Using Your Printer with Other PC Applications

You may also use other Windows applications to create labels with the K5100 printer. This is an example using **Microsoft Word** to create a label.

1. Click on the **File** menu and select **Print**.

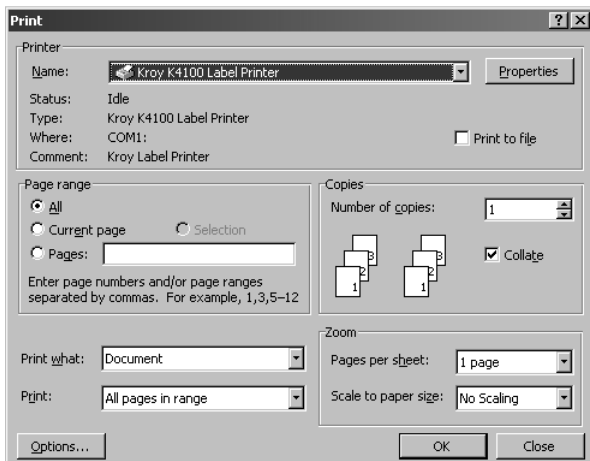

2. Select the Kroy K5100 Label Printer in the drop down box and Click **Close**.
3. Click on the **File Menu** and select **Page Setup**.

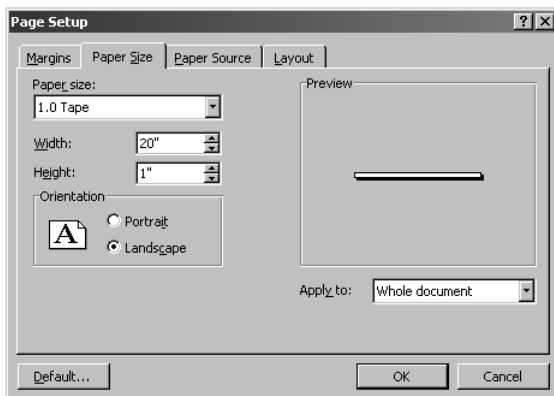

4. Click on the **Paper Size** tab and select the supply type. This size should match the size of the width on the supply cartridge currently installed in your K5100 printer. Usually you will want **Landscape** orientation selected.

5. Select the **Margins** tab and change the top, bottom, left, right, gutter, header and footer to “0” or desired margin values. The default margins must be changed since you are not printing to a full 8.5” x 11” page. For some media, Word will want to “Fix” the margins based on the maximum printable area of the media selected. In this case, 1” tape requires a 0.05” top and bottom margin. Click on **OK**.

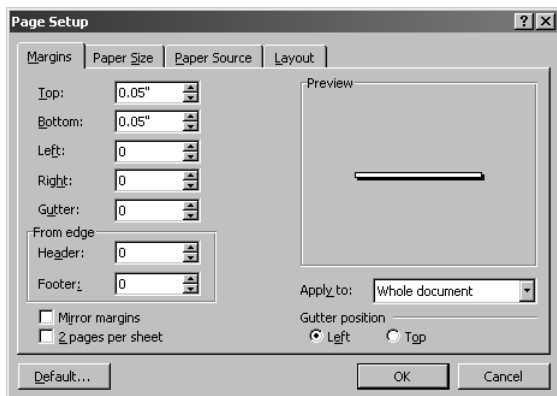

6. It is recommended to click on the **View** menu and select **Page Layout** mode.
7. A blank label template with a blinking cursor will appear on your PC monitor.
8. Enter the label text.

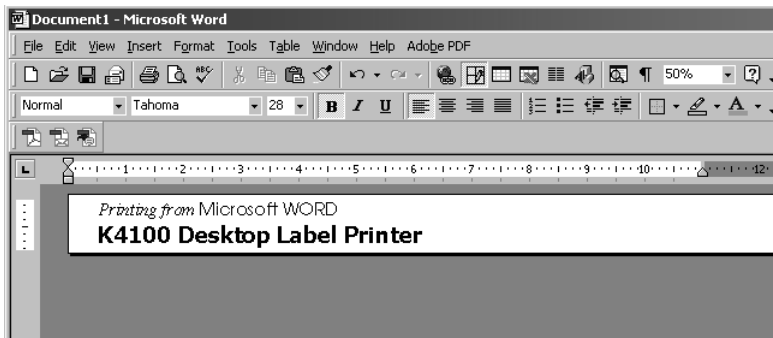

9. Select **Print** from the File menu. Make sure that the K5100 is selected and Click **OK** to print the label. *Note: When printing and the cartridge runs out of tape, remove and install a new cartridge, and press Feed to continue printing. DO NOT TURN OFF THE PRINTER.*

To **Save** your label, go to the **File** menu and select **Save**. You can also save the document as a template to start other label files.

Appendix A: Maintaining Your Printer

The printer requires no lubrication and only minimal maintenance. Occasional cleaning of the exterior surfaces and regular cleaning of the printhead and rollers are all that is required. This appendix explains how to clean these parts of your printer.

Cleaning the Printhead and Rollers

The printhead and rollers should be cleaned after every cartridge. Use isopropyl 90% alcohol on a soft cotton swab to remove adhesive buildup and tape and ribbon residue. Make sure the alcohol has evaporated before loading a supply cartridge.

Note: Avoid touching the surface of the printhead with your finger. Acids and oils on your skin will damage the printhead.

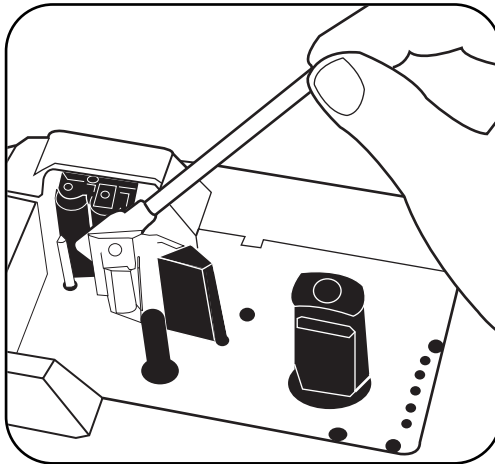

Appendix B: System Messages

The following are system messages that the K5100 will display and an explanation of each message.

Cannot Save No Memory	(1) There is not enough memory to save your file. Either delete unneeded files or simplify labels by reducing the amount of text or the number of formatting options they contain. (2) You tried to save a file to drive B when it is write protected.
Cartridge Empty	Cartridge supply is empty. Install a new cartridge.
Font Size Too Big	The point size is too large for the number of lines you have entered. Reduce the point size or select fewer lines.
Size Too Small	Auto size has calculated a size smaller than the minimum size of 4 pt.
Font Error!	You entered the wrong number of characters for the bar code. Check the requirements for the type of bar code you are using and enter the correct number of characters.
No Cartridge	Install a cartridge in order to print.
No Files Found	You selected Open or Delete but have no files saved in memory. You must save files before you can open or delete them.
Printer Too Hot	The printer is too hot to print labels. Wait about five minutes and then resume printing. This message may also appear when the printer is used in an ambient temperature below its minimum rated operating temperature.
Printing...	The printer is printing labels. No action required.

Appendix C: Troubleshooting

This appendix explains how to solve some common problems that may arise when you are using the printer. If you are unable to correct the problem contact your Dealer or Kroy Customer Service. In the United States, call (800)347-5769; in Europe call +44-(0)118-986-5200.

Display stays black/blank after printer is turned on

- Adjust the LCD Contrast
- Make sure the AC Adapter is firmly connected or the optional batteries are fully charged

Printer does not print

- Ensure the lock/release knob is in the locked position
- Check the supply cartridge and its position
- Check that the AC adapter and/or serial cable is firmly connected

Printed characters are not formed properly

- Adjust the print density
- Clean the printhead and rollers

Printed characters have a line through them and/or voids

- Turn off printer and use a Kroy Cleaning Kit (Part#255900) or use 90% or better isopropyl alcohol on a cotton swab to clean the printhead and rollers (See Appendix A) for instructions.

Printer isn't working properly

- Reset the printer
- Turn the printer on and off

Printer has locked up

- Turn the printer on and off

Appendix D: Updating Firmware

Updating Firmware

Updates for firmware can be found at www.kroy.com. Go to support and click on downloads.

1. **Connect** the serial cable to your Com port of choice and to your printer.
2. **Download** the updated file from our site.
3. **Save** the file to your PC.
4. Go to your **Start Menu** of your PC and go to **Settings** and select **Printers**.
5. Right click on the K5100 driver and go to **Properties**.
6. Click on **Control** and go to **Advance Options...**

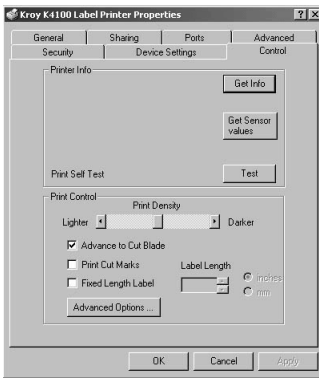

7. Select **Download Firmware** from the menu and click **Update**.

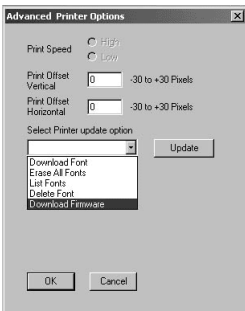

8. A warning will appear below and click **Yes** to continue.

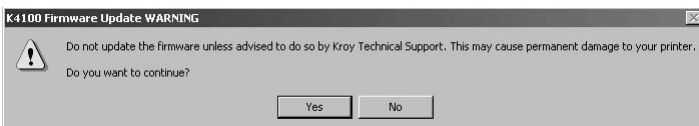

9. Select the firmware file and click **Open**.

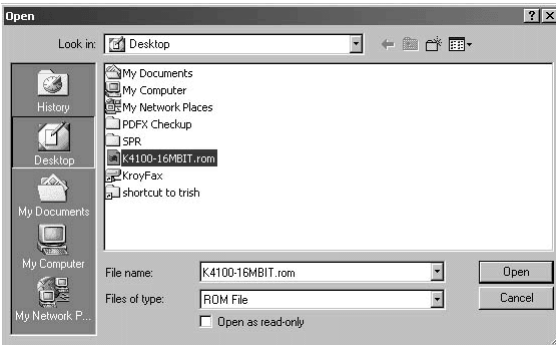

10. The printer will then update the file.

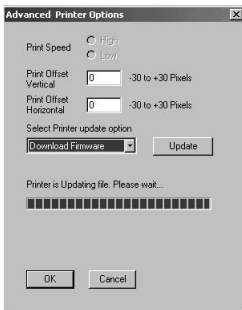

The LCD Display will show the progress of the download using the pound sign(#) across the bottom. The printer will show a receiving and an updating display.

Receiving...
#####

Updating...
#####

9. The download is now complete.

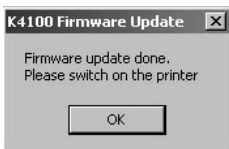

Appendix E: Using Accent Characters

K5100 has a variety of international characters and symbols found in **Blue** on the keypad. Use the **Alt** key + the accent character and/or symbol to print out these special accent characters.

In our example, we will use the ´ accent character and add it to the letter “i” in “Factoría” (Factory).

The “i” in “Factoría” must be accented. To do this, you will hold down the **Alt** +  key on the keypad. This activates the accent character. You will then press the letter “i” on the keypad. The printer will then display the accented character in the text of the label.

1:Factoría _
2:

Accent Character Guide

^	aAeEiloOuU
~	aAnNoO
¨	aAeEiloOuUyY
˘	aAeEiloOuU
˙	aAeEiloOuUyY

Appendix F: Using the Character Map

The K5100 has the capability to accept code to print characters not found on the keyboard. To use the character map, the **Extended Mode** must be on. To turn the **Extended Mode** on press the **Alt** and **Space** key together. To turn this mode off, press the **Alt** and **Space** key together again. See the character set below for ASCII codes to assist you.

To enter characters in extended mode, enter the 4 digit code shown in the table below. Most of the characters will be properly displayed on the LCD. For some characters, a solid block place holder will display on the LCD, but the selected character will print on the label.

ASCII Code	Character	ASCII Code	Character	ASCII Code	Character
0123	{	0204	ì	0231	ç
0124		0205	í	0232	è
0125	}	0206	î	0233	é
0126	~	0207	ï	0234	ê
0140	Œ	0208	Ð	0235	ë
0156	œ	0209	Ñ	0236	ì
0159	ÿ	0210	Ò	0237	í
0162	¢	0211	Ó	0238	î
0163	£	0212	Ô	0239	ï
0165	¥	0213	Õ	0240	ð
0168	¨	0214	Ö	0241	ñ
0176	°	0215	×	0242	ò
0177	±	0216	∅	0243	ó
0180	´	0217	Ù	0244	ô
0191	¿	0218	Ú	0245	õ
0192	À	0219	Û	0246	ö
0193	Á	0220	Ü	0247	÷
0194	Â	0221	Ý	0248	ø
0195	Ã	0222	Þ	0249	ù
0196	Ä	0223	ß	0250	ú
0197	Å	0224	à	0251	û
0198	Æ	0225	á	0252	ü
0199	Ç	0226	â	0253	ý
0200	È	0227	ä	0254	þ
0201	É	0228	å	0255	ÿ
0202	Ê	0229	ä		
0203	Ë	0230	æ		